



155Mb/s SFP BIDI Transceiver

APSB43013xxL80

■ Product Features

- ✓ Up to 155Mb/s data links
- ✓ Single LC connector
- ✓ Hot-pluggable SFP footprint
- ✓ 1490nm DFB laser transmitter
- ✓ RoHS compliant and Lead Free
- ✓ Up to 80Km on 9/125um SMF
- ✓ Metal enclosure for lower EMI
- ✓ Single +3.3V power supply
- ✓ Low power dissipation <800mW (0~70°C), <1000mW (-40~85°C)
- ✓ Commercial and industrial operating temperature optional
- ✓ SFP MSA SFF-8074i Compliant



■ Applications

- ✓ SONET OC-3 / SDH STM -1
- ✓ Fast Ethernet

■ General

ATOP's APSB43013xxL80 Small Form Factor Pluggable (SFP) transceivers are compatible with the Small Form Factor Pluggable Multi-Sourcing Agreement (MSA). The SFP transceivers are high performance, cost effective modules supporting SONET OC-3/SDH STM-1 and 80km transmission distance with SMF. They are RoHS compliant and lead-free.

■ Product Selection

Part Number	Operating temperature	DDMI
APSB43013CXL80	Commercial	No
APSB43013CDL80	Commercial	Yes
APSB43013IXL80	Industrial	No
APSB43013IDL80	Industrial	Yes



■ Regulatory Compliance

- ESD to the Electrical PINs: compatible with MIL-STD-883 Method 3015
- ESD to the Single LC Receptacle: compatible with IEC 61000-4-2
- Immunity compatible with IEC 61000-4-3
- EMI compatible with FCC Part 15 Class B EN55022 Class B (CISPR 22B) VCCI Class B
- Laser Eye Safety compatible with FDA 21CFR 1040.10 and 1040.11 EN60950, EN (IEC) 60825-1,2
- RoHS compliant with RoHS 2 (2011/65/EU)

■ Pin Descriptions

Pin	Symbol	Name/Description	Ref.
1	VeeT	Transmitter Ground (Common with Receiver Ground)	1
2	TX Fault	Transmitter Fault.	
3	TX Disable	Transmitter Disable. Laser output disabled on high or open.	2
4	MOD_DEF(2)	Module Definition 2. Data line for Serial ID.	3
5	MOD_DEF(1)	Module Definition 1. Clock line for Serial ID.	3
6	MOD_DEF(0)	Module Definition 0. Grounded within the module.	3
7	Rate Select	No connection required	
8	LOS	Loss of Signal indication. Logic 0 indicates normal operation.	4
9	VeeR	Receiver Ground (Common with Transmitter Ground)	1
10	VeeR	Receiver Ground (Common with Transmitter Ground)	1
11	VeeR	Receiver Ground (Common with Transmitter Ground)	1
12	RD-	Receiver Inverted DATA out. AC Coupled	
13	RD+	Receiver Non-inverted DATA out. AC Coupled	
14	VeeR	Receiver Ground (Common with Transmitter Ground)	1
15	VccR	Receiver Power Supply	
16	VccT	Transmitter Power Supply	
17	VeeT	Transmitter Ground (Common with Receiver Ground)	1
18	TD+	Transmitter Non-Inverted DATA in. AC Coupled.	
19	TD-	Transmitter Inverted DATA in. AC Coupled.	
20	VeeT	Transmitter Ground (Common with Receiver Ground)	1

Notes:

1. Circuit ground is internally isolated from chassis ground.
 2. Laser output disabled on TX Disable >2.0V or open, enabled on TX Disable <0.8V.
 3. Should be pulled up with 4.7k - 10kohms on host board to a voltage between 2.0V and 3.6V.
- MOD_DEF (0) pulls line low to indicate module is plugged in.
4. LOS is open collector output. Should be pulled up with 4.7k – 10kohms on host board to a voltage between 2.0V and 3.6V. Logic 0 indicates normal operation; logic 1 indicates loss of signal.



Pin-out of Connector Block on Host Board

■ **Recommend Circuit Schematic**





■ **Absolute Maximum Ratings**

Parameter	Symbol	Min	Typ	Max	Unit	Ref.
Maximum Supply Voltage	Vcc	-0.5		+4.0	V	
Storage Temperature	TS	-40		+85	°C	
Operating Humidity	RH	0		85	%	

■ **Recommended Operating Conditions**

Parameter	Symbol	Min	Typ	Max	Unit	Ref.
Power Supply Voltage	Vcc	3.13	3.30	3.47	V	
Power Supply Current	Icc			250	mA	Commercial
	Icc			300	mA	Industrial
Case Operating Temperature	Tc	0		+70	°C	1
	Tl	-40		+85		2
Data Rate			155		Mbps	
9/125um G.652 SMF	Lmax			80	km	

Notes:

1. For commercial class product.
2. For industrial class product.

■ **Electrical Characteristics (TOP=25°C, Vcc=3.3Volts)**

Parameter	Symbol	Min	Typ	Max	Unit	Ref.
Transmitter						
Input differential impedance	Rin		100		Ω	1
Single ended data input swing	Vin, pp	250		1200	mV	
TX Disable-High		Vcc – 1.3		Vcc	V	
TX Disable-Low		Vee		Vee+ 0.8	V	
TX Fault-High		Vcc-0.5		Vcc	V	
TX Fault-Low		Vee		Vee+0.5	V	
Receiver						



Single ended data output swing	Vout, pp	300	400	800	mV	2
Data output rise time	tr			1500	ps	3
Data output fall time	tf			1500	ps	3
LOS-High		Vcc – 0.5		Vcc	V	
LOS-Low		Vee		Vee+0.5	V	

Notes:

1. AC coupled.
2. Into 100 ohm differential termination.
3. 20 – 80 %

■ **Optical Characteristics (TOP=25°C, Vcc=3.3 Volts)**

Parameter	Symbol	Min	Typ	Max	Unit	Ref.
Transmitter						
Output Opt. Power	PO	-5		0	dBm	1
Optical Wavelength	λ	1470	1490	1510	nm	
Spectral Width(-20dB)	$\Delta \lambda$			1	nm	
Side Mode Suppression Ratio	SMSR	30			dB	
Optical Rise/Fall Time	tr/tf			1500	ps	2
Jitter Generation (RMS)				0.01	UI	
Jitter Generation (pk-pk)				0.1	UI	
Optical Extinction Ratio	ER	10			dB	
Receiver						
RX Sensitivity @155 Mb/s	SENS			-34	dBm	3, 4
Receiver Overload		-10			dBm	
Optical Center Wavelength	λ_C	1263	1310	1360	nm	
LOS De-Assert	LOSD			-35	dBm	
LOS Assert	LOSA	-45			dBm	
LOS Hysteresis		0.5		5	dB	

Notes:

1. Class 1 Laser Safety.
2. Unfiltered, 20-80%. Complies with OC-3 eye masks when filtered.

3. Measured with conformance signals defined in FC-PI-2 Rev. 10.0 specifications.
4. Measured with PRBS $2^{23} - 1$ at 10^{-10} BER.

■ Mechanical Specifications

ATOP's Small Form Factor Pluggable (SFP) transceivers are compatible with the dimensions defined by the SFP Multi-Sourcing Agreement (MSA), dimensions are in mm.

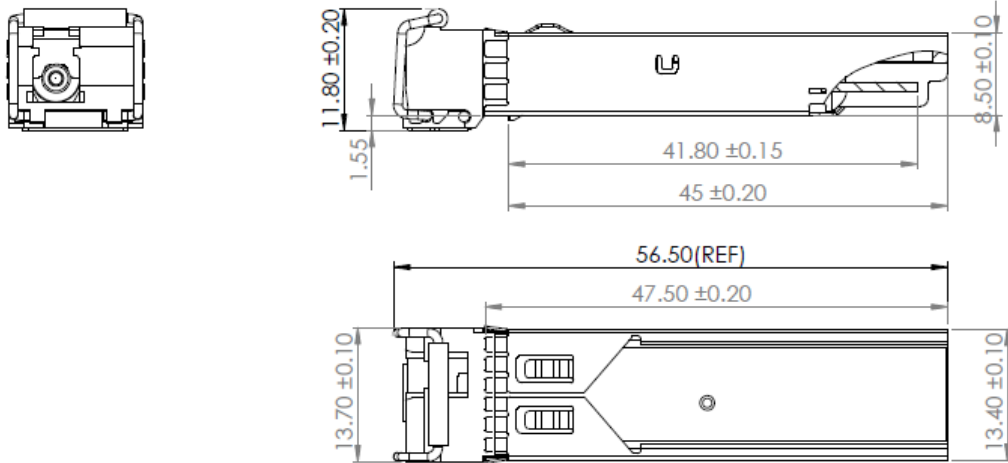

APSB43013xxL80

■ EEPROM Information

EEPROM memory map specific data field description is as below:

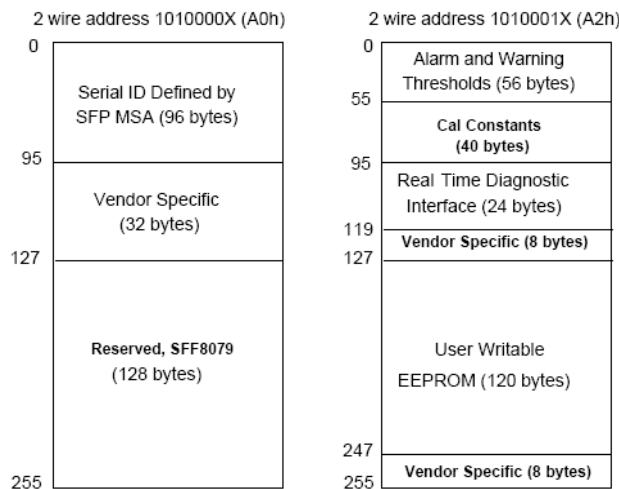



■ Digital Diagnostic Monitoring Interface

Five transceiver parameter values are monitored. The following table defines the monitored parameter's accuracy.

Parameter	Range	Accuracy	Calibration
Temperature	0 to +70°C (C)	±3°C	Internal
	-40 to +85°C (I)		
Voltage	2.97 to 3.63V	±3%	Internal
Bias Current	0 to 100mA	±10%	Internal
TX Power	-5 to 0dBm	±3dB	Internal
RX Power	-34 to -10dBm	±3dB	Internal

■ Revision History

Revision	Initiated	Reviewed	Approved	DCN	Release Date
Version1.0	vangpeiyun	sunbin	dingzheng	New Released.	July 29, 2016

■ For More Information

ATOP Corporation

Tel: +86-755-86674946

Fax: +86-755-86296723

Email: sales@atoptechnology.com

Web: www.atoptechnology.com