

CWDM MUX or DEMUX Simplex

Product Description

ATOP's Coarse Wave Division Multiplexing (CWDM) modules combine or split up to 18 wavelengths into a single fiber. CWDM technology uses ITU standard 20nm spacing between the wavelengths, from 1270nm to 1610nm. Our CWDM module has 4 to 18 channels. The central wavelength of each channel is specified to one of the ITU-T grid wavelengths. The CWDM module features wide channel bandwidth (13nm). Its isolation is greater than 30dB for adjacent channels, and greater than 40dB for non-adjacent channels. The module also has high thermal stability to ensure reliable performance under different environment

Product Features

- Low Insertion Loss
- High Isolation
- Low PDL
- Compact Design
- Good channel-to-channel uniformity
- Wide Operating Wavelength: From 1260nm to 1620nm
- Wide Operating Temperature: From -40 to 85°C

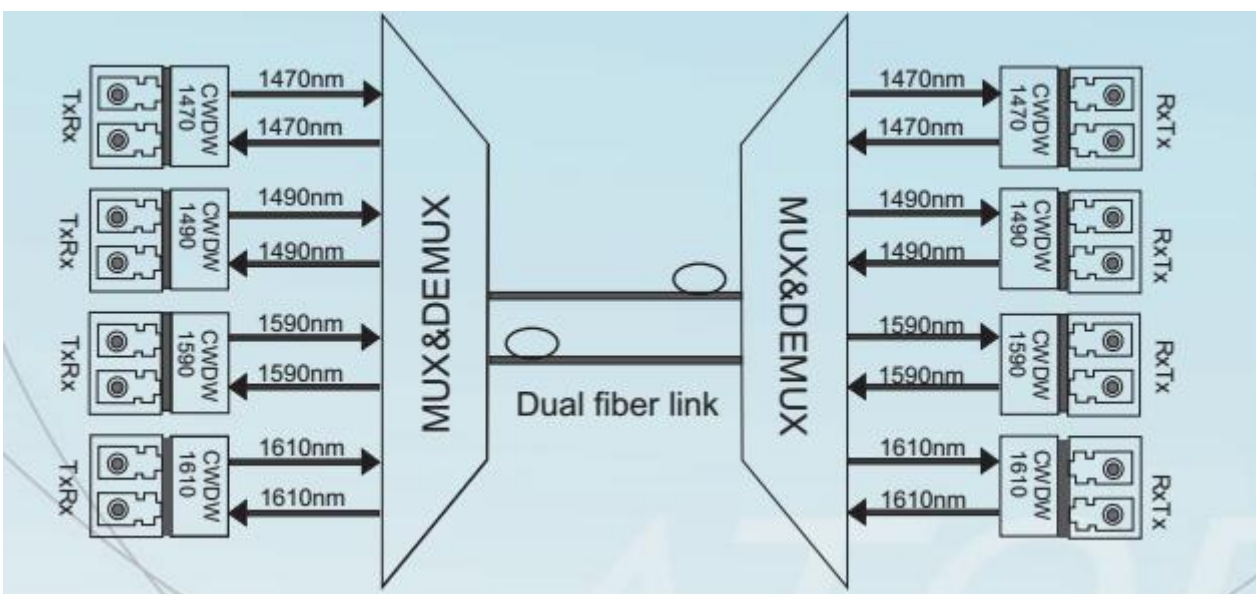

4 channels Simplex BIDI Transmission CWDM Mux & DEMUX CWDM Duplex Mux & Demux



Application

CWDM System	CATV Links
PON Networks	

Key Features

Low insertion loss	Compact Design
High isolation	Good channel-to-channel uniformity
Low PDL	Wide operating Wavelength: From 1260 nm to 1620 nm
Wide Operating Temperature	From -40 to 85°C

Compliance

Telcordia GR-1209-CORE-2001	RoHS
Telcordia GR-1221-CORE-1999	

Duplex CWDM Mux & Demux

Parameters	Unit	CWDM Module				
Center Wavelength	nm	ITU, ITU+1				
Wavelength Range	nm	1260 ~ 1620				
Channel center wavelength	nm	1270 / 1290 / ... / 1610 or 1271 / 1291 / ... / 1611				
Channel Spacing	nm	20				
Channel Passband	nm	$\lambda_c \pm 7.5$				
Channel No.	λ	2	4	8	16	18
Insertion Loss	dB	≤ 0.8	≤ 1.5	≤ 2.5	≤ 5.2	≤ 6.4
Adjacent Channel	dB	≥ 30				
Non-adjacent Channel	dB	≥ 40				
Wavelength thermal	nm/°C	≤ 0.003				
Insertion loss thermal	dB/°C	≤ 0.005			≤ 0.007	≤ 0.008
PDL	dB	≤ 0.1	≤ 0.15	≤ 0.15	≤ 0.20	≤ 0.25
Polarization Mode Dispersion	ps	≤ 0.1			≤ 0.15	
Directivity	dB	≥ 50				
Return loss	dB	≥ 45				
Optical power	mW	≤ 500				
Operating temperature	°C	-10 ~ +70				



Connects fiber to your home

ATOP Corporation

AP-CWDM-8MDS-LGX

Storage temperature	°C	-40 ~ +85
Relative humidity	%	5 ~ 95
Dimension		ABS Box or LGX Box or 1U(2U) Rack-mount
LGX Package		1U, 2U
19" Rack Mount		1U
<p>Note:</p> <ol style="list-style-type: none"> 1, Customization is available. 2, We can make low insertion loss solution as well. 3, For more information, please feel free to contact at sales@atopgofiber.com. 4, Specified without connector, and add an additional 0.2dB loss per connector. 		

For More Information

ATOP Technology

Web: www.atoptechnology.com

Email: sales@atoptechnology.com

Tel: 86-755-86674946